

The background of the entire page is a terrazzo pattern, featuring a light-colored base with scattered, irregular speckles of various colors including teal, red, yellow, and grey. A solid light blue horizontal band is positioned in the center, serving as a backdrop for the text.

THE BAR BOX

Brand Guidelines

By Rodothea Papachristoforou

Logos

Primary Logo

THE _____
BAR BOX
Sustainable soap container

Secondary Logos



Fonts

The Bar Box

Brasika

**Aa, Bb, Cc, Dd, Ee, Ff,
Gg, Hh, Ii, Jj, Kk, Ll,
Mm, Nn, Oo, Pp, Qq,
Rr, Ss, Tt, Uu, Vv,
Ww, Xx, Yy, Zz.**

Primary Font

Arima

Aa, Bb, Cc, Dd, Ee, Ff,
Gg, Hh, Ii, Jj, Kk, Ll, Mm,
Nn, Oo, Pp, Qq, Rr, Ss,
Tt, Uu, Vv, Ww, Xx, Yy,
Zz.

Secondary Font

Pattern

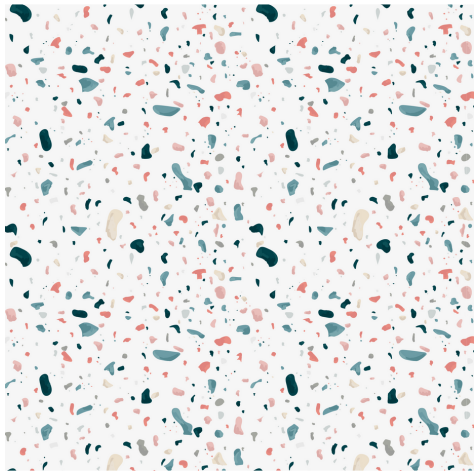

Colours

#819BA1

#DEBFB9

#DBD4CF

#C5D3EA

Branding Mockups

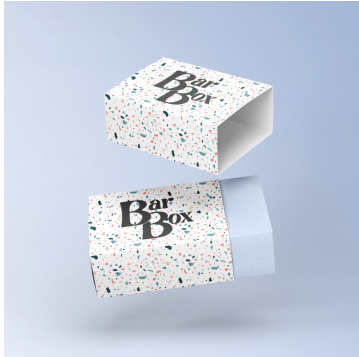

Product Sketches

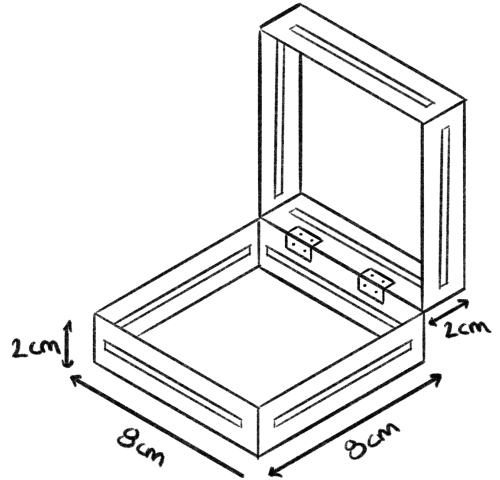
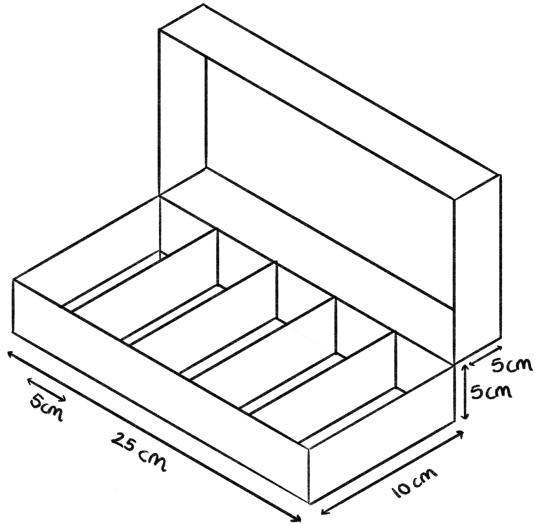

Small Box Dimensions

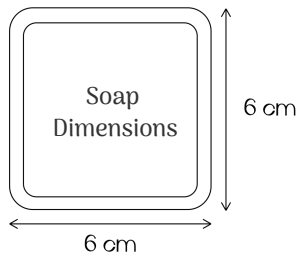

Top of small box

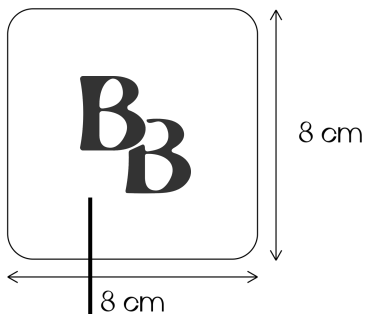

'BB' Logo engraved on the top of the box

Inside of small box

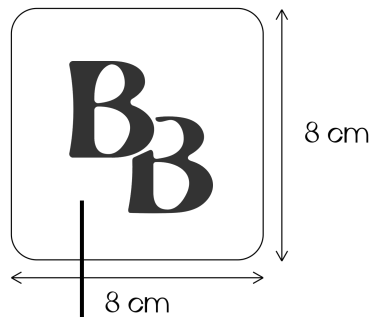

'BB' Logo engraved on the inside of the box to act as the drainage

Small Box Dimensions

Front of the small box

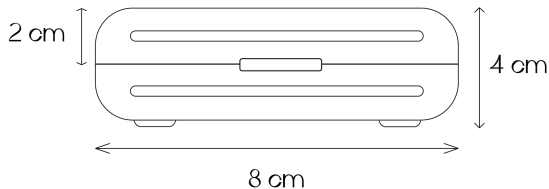

Back of the small box

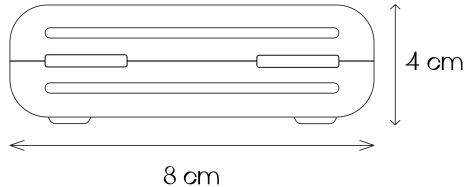

Side of the small box

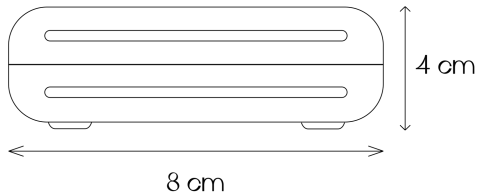

Big Box Dimensions

Big Container front view

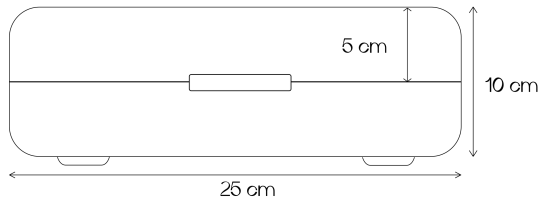

Big Container back view

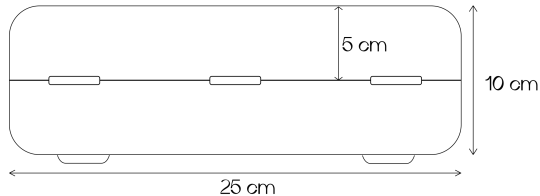

Bigger Container top inside view

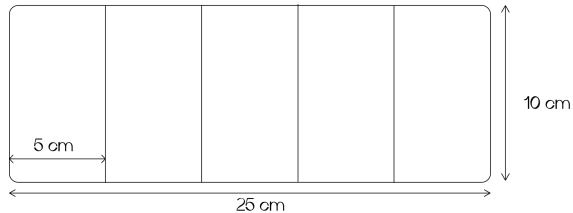

Big Container side view

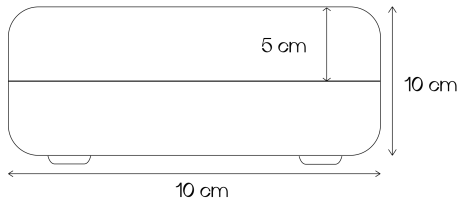

3D Model



3D Model



3D Model



3D Model

